

Pressed female reducers

RPCFL



Description

RPCFL – Pressed symmetric female-male reducer with EPDM gasket.

- ∅d₁ – coupling slips directly over SPIRAL®system fittings.
- ∅d₂ – fits SPR ducts.

Example identification

Product code: **RCFPL - aaa - bbb**

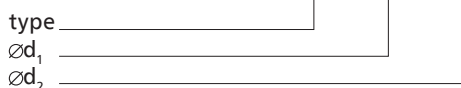

Dimensions

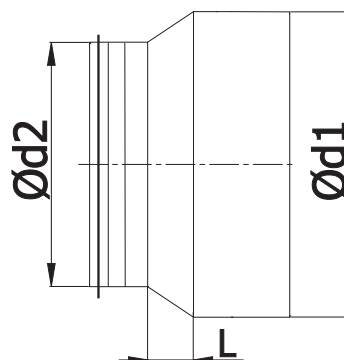

∅d _{1 rated} [mm]	∅d _{2 rated} [mm]	L [mm]	weight [kg]
100	80	18	0,20
125	80	28	0,20
	100	22	0,20
140	100*	30	0,20
	125	30	0,20
150	100	35	0,20
	125	30	0,20
	140	30	0,20
160	80	48	0,30
	100	37	0,30
	125	26	0,20
	140	30	0,30
	150	30	0,30
	160	30	0,30
180	125*	40	0,30
	140*	30	0,30
	150*	30	0,30
	160	30	0,30
200	100	58	0,40
	125	46	0,40
	140*	40	0,30
	150	35	0,30
	160	26	0,30
	180*	30	0,30
224	150*	50	0,40
	160*	50	0,40
	180*	30	0,40
	200	30	0,40

Pressed female reducers

RPCFL

Dimensions

$\varnothing d_{1, rated}$ [mm]	$\varnothing d_{2, rated}$ [mm]	L [mm]	weight [kg]
250	125	70	0,50
	150	60	0,50
	160	53	0,50
	180*	50	0,40
	200	31	0,60
	224*	50	0,50
280	160*	80	0,60
	180*	70	0,60
	200*	60	0,60
	224*	40	0,60
300	200*	70	0,70
	224*	60	0,70
	250*	30	0,60
	280*	30	0,70
315	160	88	0,80
	180*	90	0,80
	200	68	0,70
	224*	60	0,70
	250	43	0,70
	280*	40	0,70
	300*	38	0,70
355	200*	110	1,10
	224*	90	1,00
	250*	70	1,00
	315*	30	0,90
400	200*	140	1,50
	224*	120	1,40
	250*	100	1,30
	315*	60	1,30
	355*	30	1,20
450	250*	140	2,00
	280*	110	1,90
	300*	100	1,90
	315*	90	1,80
	355*	60	1,70
	400*	40	1,70

$\varnothing d_{1, rated}$ [mm]	$\varnothing d_{2, rated}$ [mm]	L [mm]	weight [kg]
500	250*	128	2,20
	300*	140	2,40
	315*	120	2,20
	355*	100	2,20
	400*	70	2,10
	450*	40	2,10
560	315*	170	2,90
	355*	140	2,80
	400*	110	2,70
	450*	80	2,60
	500*	75	2,60
600	400*	130	3,10
	450*	100	3,00
	500*	70	2,70
	560*	30	2,40
630	315*	160	3,20
	400*	140	3,30
	450*	120	3,30
	500*	80	3,00
	560*	75	2,90
	600*	30	2,50

* Fabricated, the remaining entirely pressed.

Pressed reducers

RPCL/RPCFL/RPC/RPCF

Technical Data

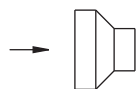

1 reduction stage

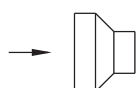
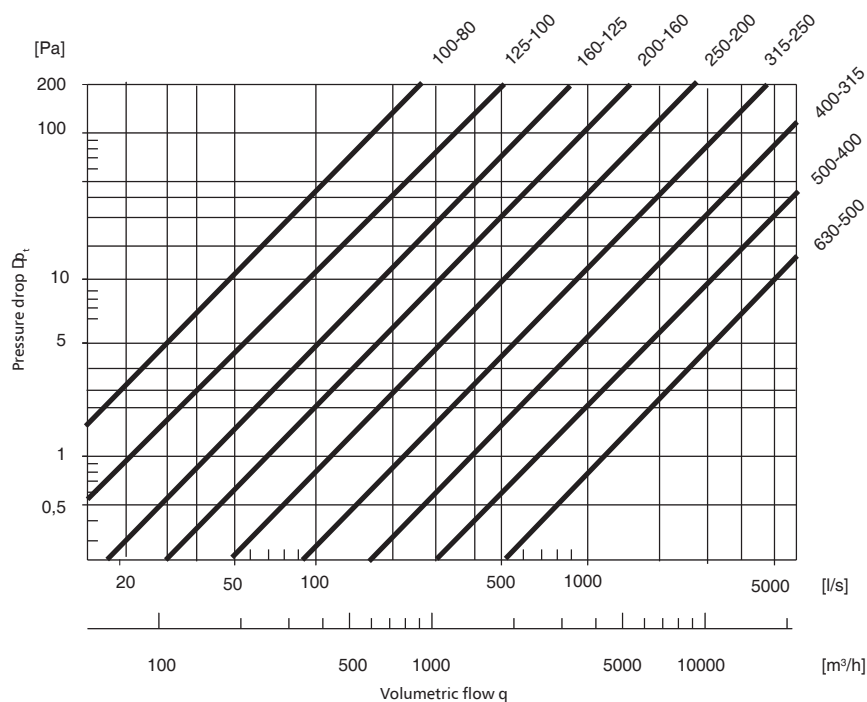

2 reduction stage

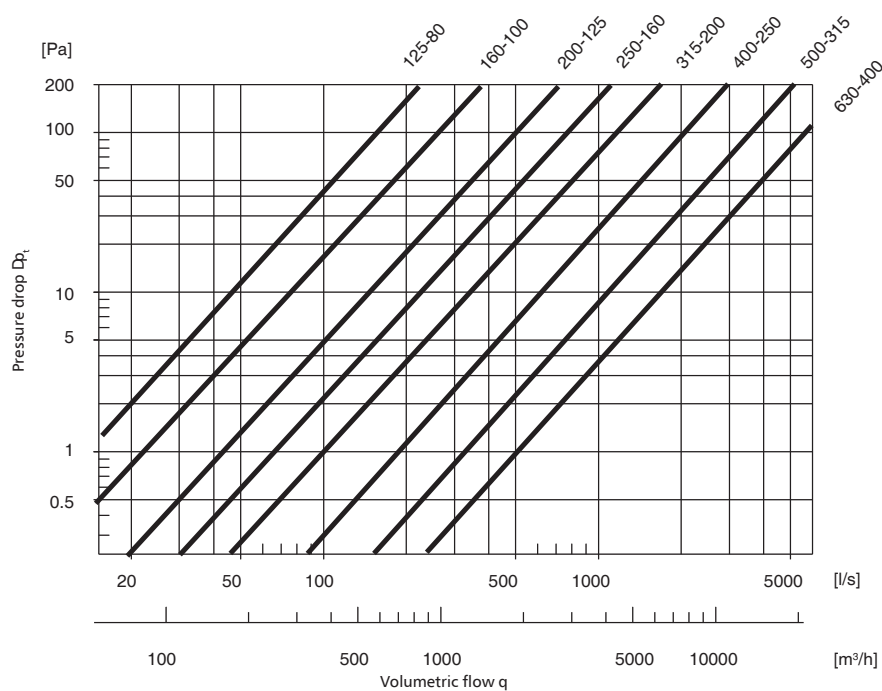

Pressed reducers

RPCL/RPCFL/RPC/RPCF/RPCN/RPCNR

Technical Data

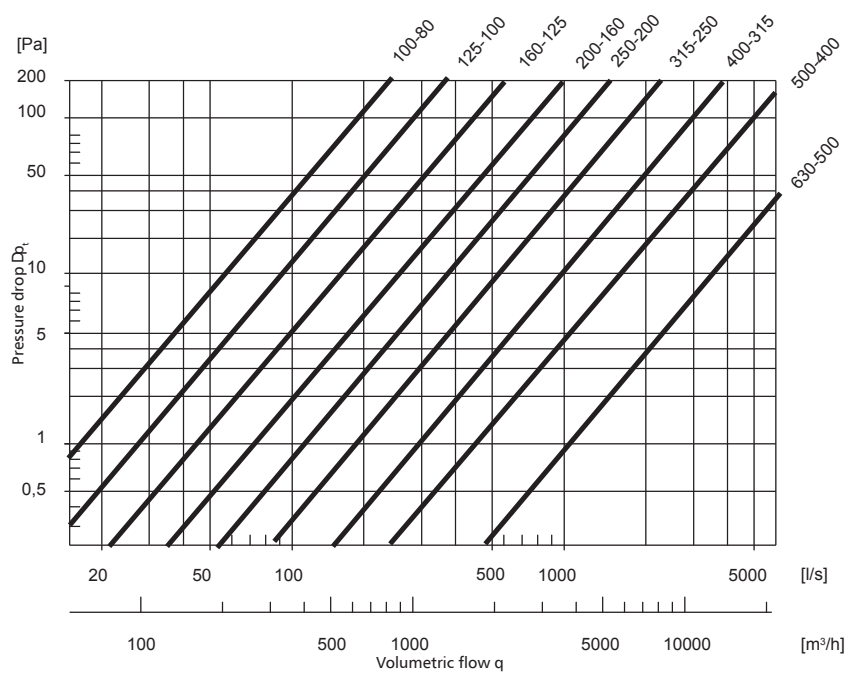
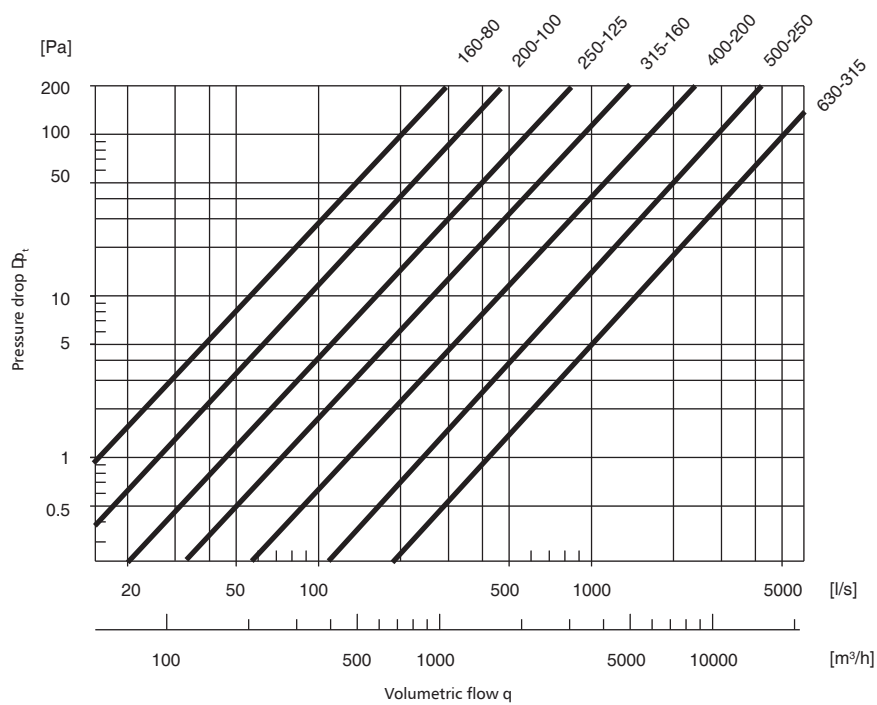
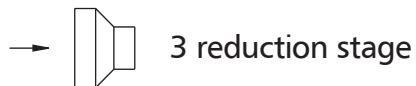

Pressed reducers

RPCL/RPCFL/RPC/RPCF/RPCN/RPCNR

Technical Data

