

## Axor Citterio

Single lever basin mixer for concealed installation with spout 225 mm and escutcheons wall-mounted

Surfaces: **chrome** Article Number: **39116000**



### Description

#### product features

- handle can be positioned on the right or left, depends on the basic set installation
- projection 220 mm
- normal spray
- flow rate: 5 l/min
- joystick ceramic cartridge
- temperature limitation not adjustable
- non-closing flush grated valve
- suitable for continuous flow water heaters
- connection dimension: DN15
- SVGW 0611-5135
- DVGW NW-6506BR5789
- P-IX 18117/IO
- ETA VA 1.42/19221
- ACS 10 ACC LY 573, valide jusqu'au 15.05.2017
- WRAS 1305018
- SINTEF 1437

#### Mandatory Accessoires

- Basic set for single lever basin mixer for concealed installation wall-mounted (#13622XXX)

#### Optional Accessoires

- Extension set 25 mm (#31971XXX)
- Flowstar design trap (#52100XXX)

### Technology



### Certificates



### Product image



### Scale drawing

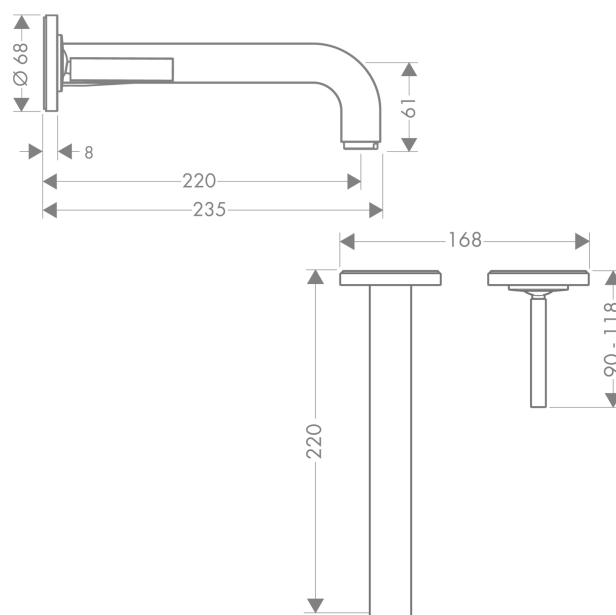

## Axor Citterio

Single lever basin mixer for concealed installation with spout 225 mm and escutcheons wall-mounted

Surfaces: **chrome** Article Number: **39116000**



### Exploded Drawing

Year of production: >01/10

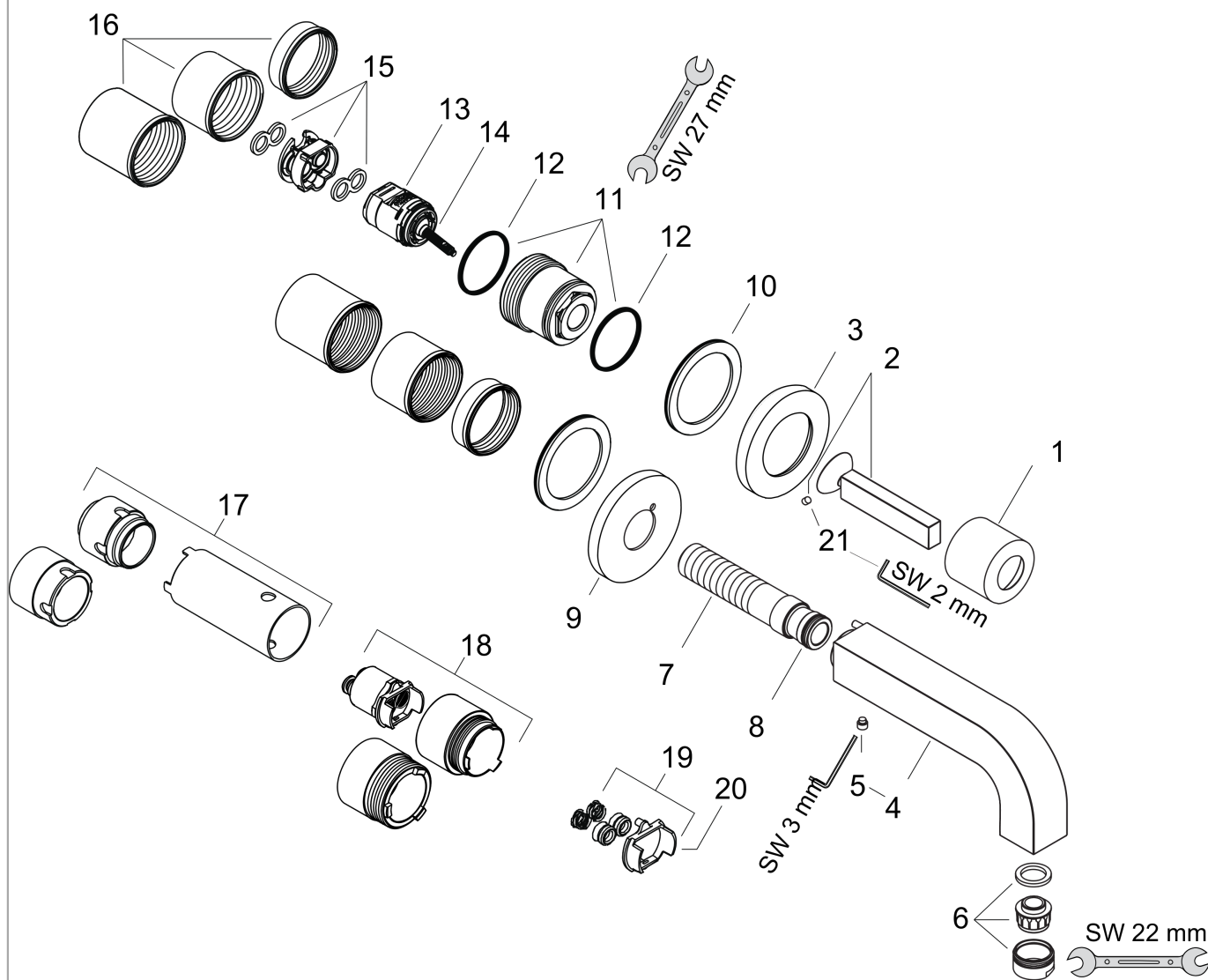

## Axor Citterio

Single lever basin mixer for concealed installation with spout 225 mm and escutcheons wall-mounted



Surfaces: **chrome** Article Number: **39116000**

### Spare part list

Year of production: >01/10

Pos.	Description	Article Number	PC	PU
1	flange	96908000	-	1
2	handle	39092000	-	1
3	escutcheon for handle	96909000	-	1
4	spout 220 mm	97239000	-	1
5	hollow set screw M6x6	97660000	-	1
6	aerator M24x1 (5 l/min)	13185000	-	1
7	connecting thread G½	97228000	-	1
8	O-ring 16x2,5	98134000	-	1
9	escutcheon	98720000	-	1
10	washer	97600000	-	1
11	nut	95645000	-	1
12	O-ring 34x2	98383000	-	1
13	cartridge, assy	96339000	-	1
14	O-ring 21,95x1,78	95169000	-	1
15	adapter for cartridge	95644000	-	1
16	fixing set	97971000	-	1
17	extension set for 13622180	31971000	-	1
18	extension set for 38111180	38982000	-	1
19	conversion kit	95643000	-	1
20	adapter for cartridge	97280000	-	1
21	hollow set screw M4x6	97767000	-	1
a	pop up waste	50001000	-	1
b	base body	13622180	-	1
c	service tool for disassembling the handle	92124000	-	1